

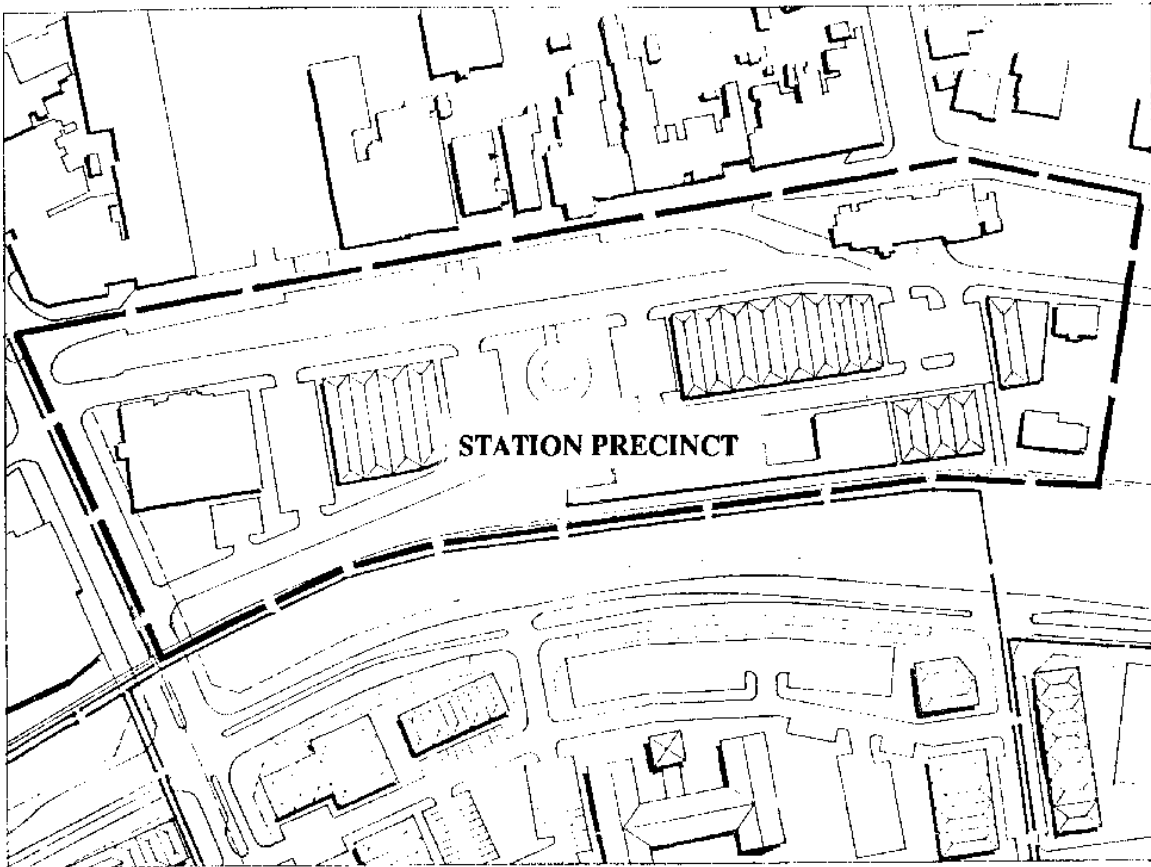

Council Policy

Station Precinct Guidelines

© City of Albany 2006



INTRODUCTION

Development with this precinct must achieve the following urban design goals:

- It must be strongly integrated with the Town proper,
- It must develop its own unique character with its own sense of place,
- It must facilitate strong connection with the future developments on the foreshore and function as a catalyst to movement between the Town and the foreshore.

It is a precinct with strict controls, in which the treatment of the facades is crucial to the character of the precinct, the type and scale of the roofs will be highly visible from Stirling Terrace and the pattern, scale and character of the development will greatly influence the appreciation of the foreshore development.

DEVELOPMENT SITES

Subdivision

The size and location of development sites is defined by the subdivisional plan below. Development sites may be amalgamated and subdivided following planning approval of an appropriate development proposal, which satisfies the development objectives, development guidelines and illustrated concept design.

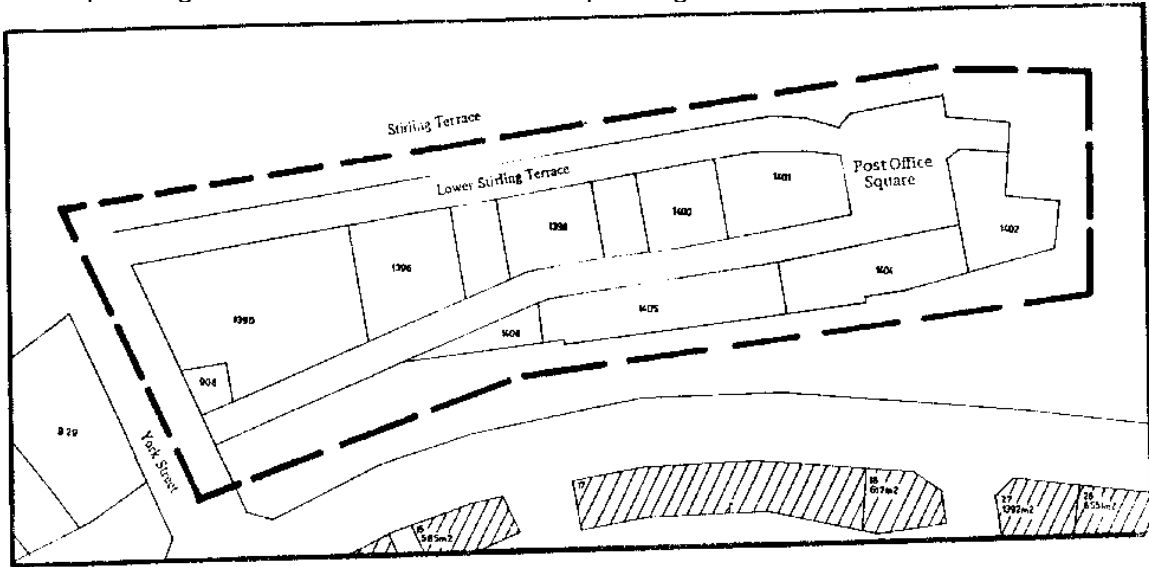

Land Tenure

The development sites defined shall be issued for:

- Freehold Purchase and/or
- Leasehold

at the discretion of the relevant authorities and under such conditions as they deem to be appropriate, which shall be in accordance with these guidelines, but not exclusively so.

Any tenancy agreements pertaining to the defined development sites shall have specific performance requirements based on the guidelines.

Site Definition

Development sites are shown hatched and communal car parking sites are shown stippled. Site boundaries may be redefined to meet the objectives of the guidelines, providing design proposals have been approved by the Albany Foreshores Development Committee.

DEVELOPMENT STANDARDS

All of the following standards shall be in accordance with the Town of Albany, Town Planning Scheme – Central Area Zone, unless otherwise noted.

Zonings/Land Uses

Various uses are permitted under the central area zone within the current Town of Albany Planning Scheme. The preferred uses are to be of a tourist orientation and by the nature of their operation be supportive of the tourism theme and/or the development of cultural facilities within the precinct.

Free standing fast food outlets, that are not integrated with adjacent shops, are unlikely to be approved, unless designed in a manner beneficial to the overall development of the precinct.

Plot Ratios

A maximum plot ration of 1.5 may be permitted, with a maximum of 2 storey height limit and 100% site cover, providing this is compatible with development in the vicinity. 3 storey development will be permitted on site 1402.

Setbacks

There are not setback requirements from any boundary. Any setbacks will need to be justified in accordance with other provisions of these guidelines. Verandahs and awnings shall be constructed within the abutting public road and other reserves.

Landscaping

This shall be provided within hospitality courtyard spaces or to make the street presentation of service yards more attractive.

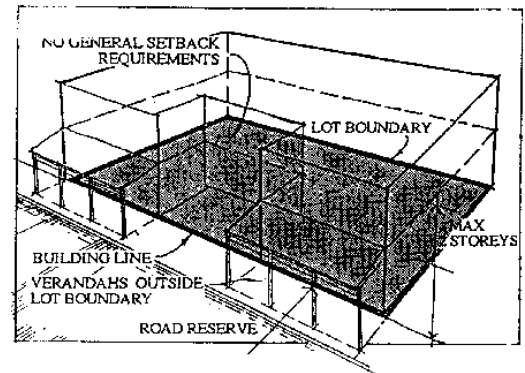

STREETSCAPE FACTORS

Streetscape

The streetscape characteristics for the rest of Upper Stirling Terrace should be emulated within this Precinct. For development this means:

- Facades constructed at the building line.
- Facades as continuous as possible.
- Footpaths sheltered by awnings or verandahs.
- Facades should be 1 or 2 storeys in height.

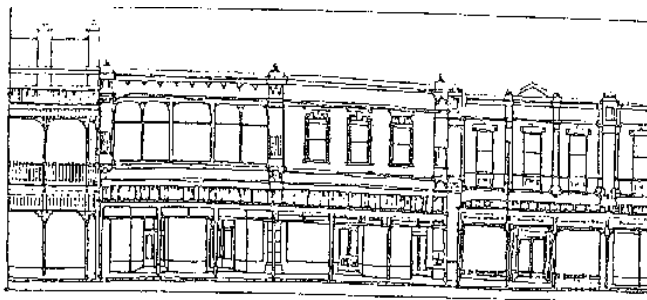

Fronts

All developments must present “fronts” to each street, ie Lower Stirling Terrace, Post Office Square and the Parade in front of the Station Communal car parks should be considered as street frontages for this purpose.

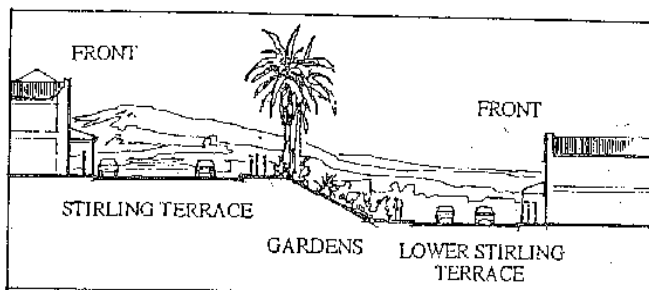

Setbacks

Generally are not encouraged, except where hospitable courtyards can be formed and to the frontage of the Railway Station.

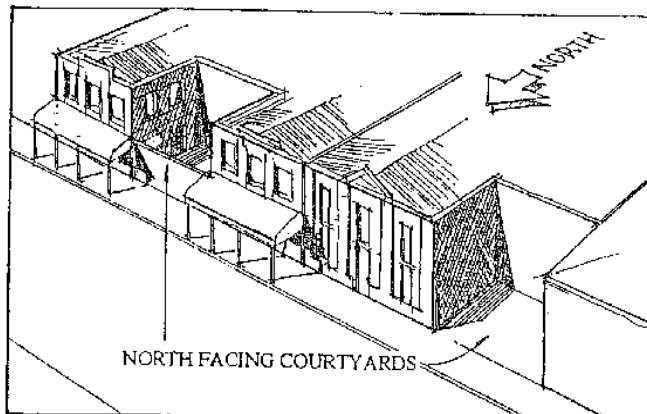

Service Yards

Should be internalised to avoid visual impact on streetscapes.

Street Furnishings

The type, nature and character of street furnishings and landscaping are illustrated in the accompanying landscape concept.

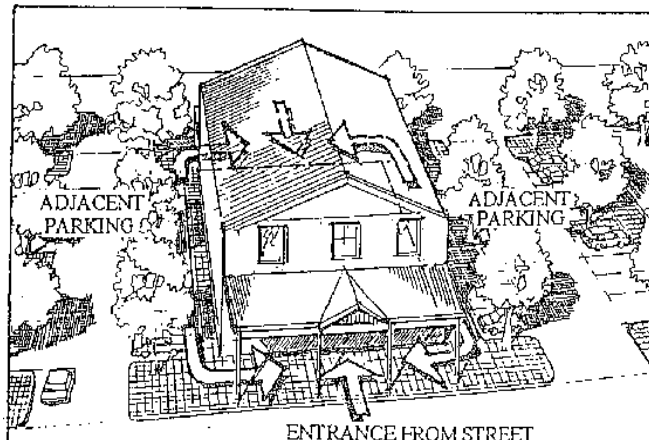

Streets, Car Parks, etc

All elements within the public domain shall be undertaken by the relevant development agencies. This will ensure a consistent character and standard of implementation. The standard of these works shall indicate the development standards expected of private developers.

Pedestrian Access

All developments shall have direct pedestrian access through street frontages.

BUILDING DETAILS

Exemplars

The buildings of Upper Stirling Terrace provide the model for the following building details, in their scale and proportions

Building Heights

All buildings shall be 1 or 2 storeys in height 4.5-8m façade heights.

Features, such as towers, may be permitted to exceed 2 storeys in height.

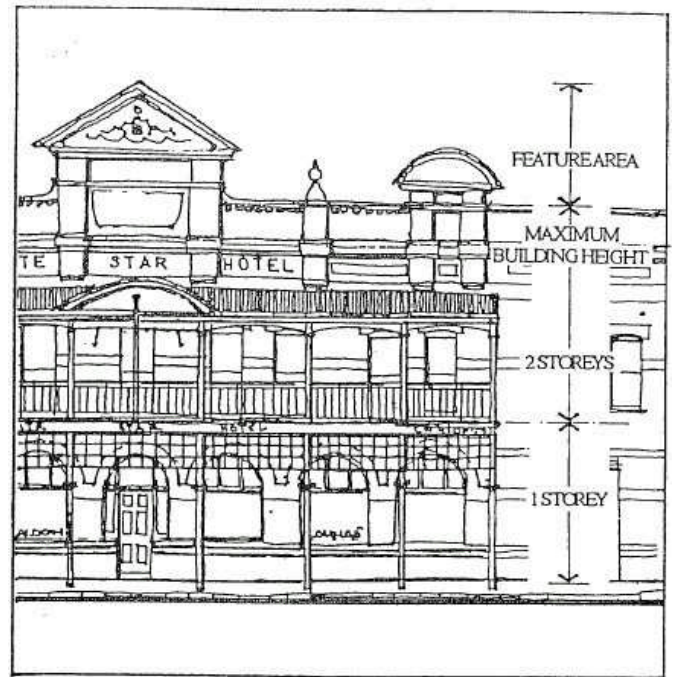

Roofs

All roofs shall be pitched. Roof pitches are to within the range 26.5 degrees (1:2) to 45 degrees (1:1).

From eave to ridge roof heights shall not exceed 4m.

Generally roof ridges shall run normal to Stirling Terrace.

Roofs shall be gabled or hipped ends, unless parapeted.

Generally eaves shall be finished flush with walls, unless forming a verandah.

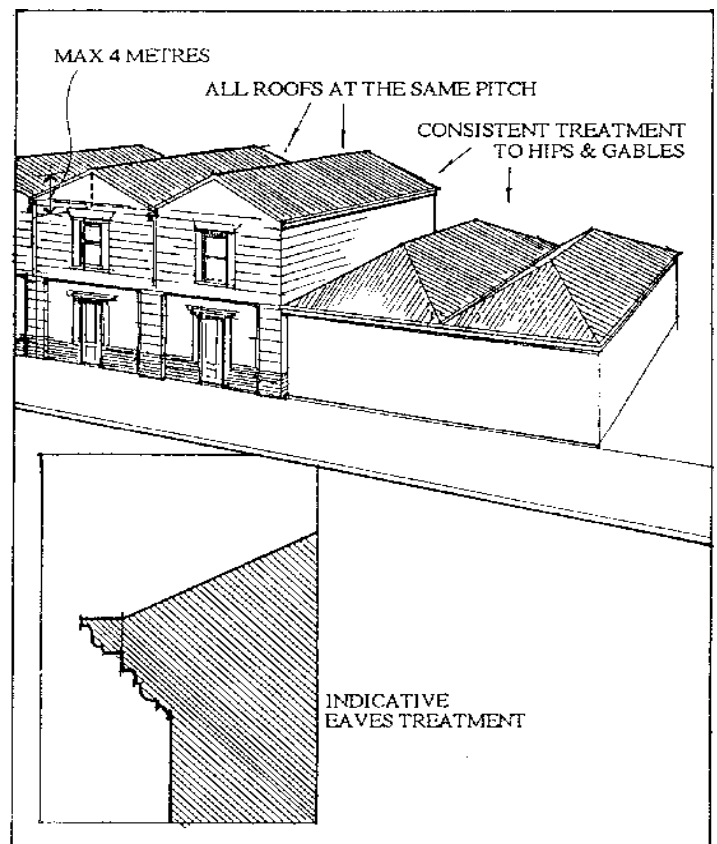

Walls

Generally walls shall be of masonry or timber construction with holes for windows and doors.

Walls should be articulated into a base, middle and capping as per the Stirling Terrace exemplars.

Walls should be articulated into bays not exceeding 6m in length.

Exceptions to this shall be retail frontages under verandahs or awnings, where the proportion of void to solid may increase as per the exemplars.

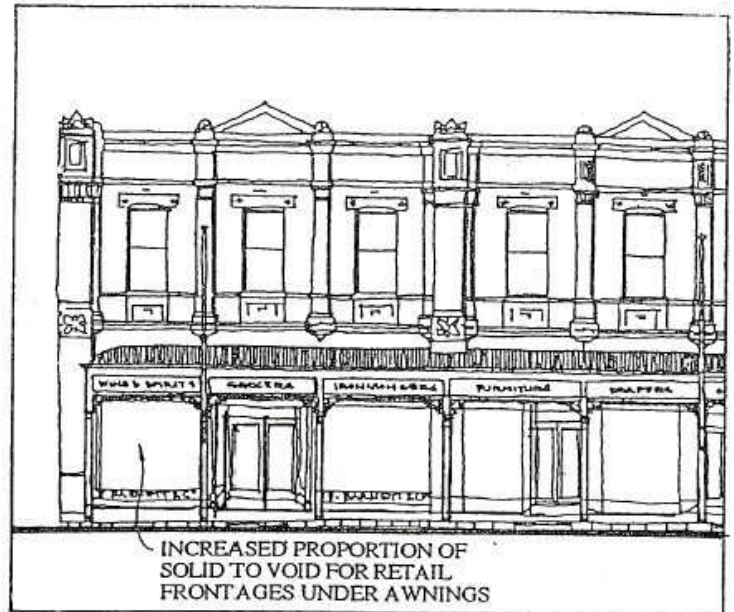

Openings

Apart from retail frontages door and window openings shall be inset from the façade by, at least 125mm. Openings should be articulated to set up façade rhythms as per the exemplars.

Door openings shall be indented from the facade by, at least, 750mm.

Retail frontages shall consist of:

- Tiled recessed entry.
- Thin timber or bronze shopfittings.
- Timber or tiles stall boards.
- Plate glass glazing.
- Timber part-glazed doors.

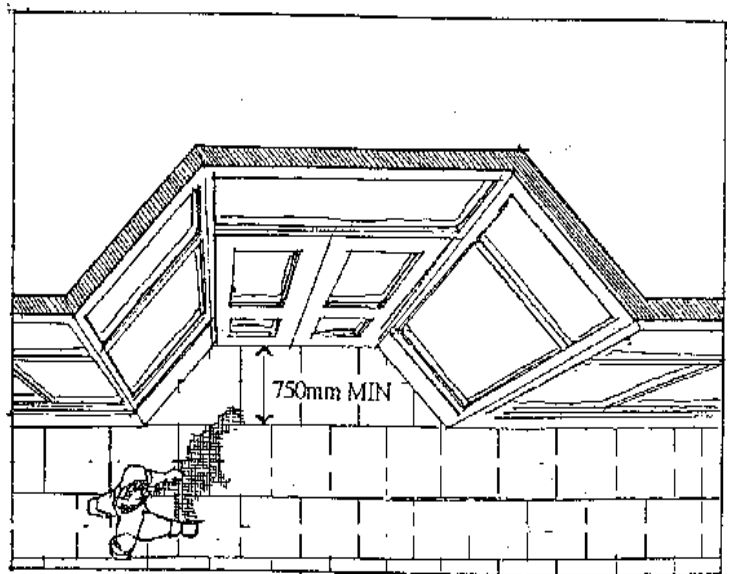

Verandahs and Awnings

These shall comply with the dimensions shown opposite.

As far as possible there shall be continuity of shelter for pedestrian movement provided by verandahs and awnings.

Traditional structures and roofing materials shall be used.

Materials

The range of materials, traditionally used, and the relative extent of their use, are as follows:

- Brickwork, equivalent to dark blend Albany bricks or light blend Albany bricks.
- Painted render using Classical Revival proportioning and details.
- Painted timber boarding, joinery and verandah Glazing generally clear glass to windows, clear etched or patterned to door lights.
- Painted signs with external illumination only, when provided.
- Roofs in iron or shingle.

Colours

The traditional palette of colours used in this part of Albany is as follows:

Walls

Various ochre shades, cream, off-white, light pink, grey/blue.

Highlights

Black, dark brown, chocolate brown, dark green, rust.

Joinery

Dark Green, black, white, beige, turquoise, various browns.

Tiling

Dark green, mid-brown, white, coloured frieze tiles.
Verandah Dark green, mid to dark brown, white.

Roofs

Grey shingles or iron. Where visible this should be painted in dark green, dark red and/or cream.

Colour Schemes

Recommended colours are provided in Appendix 2. Contemporary colour palettes will be considered, however approvals must be obtained from the Town of Albany.

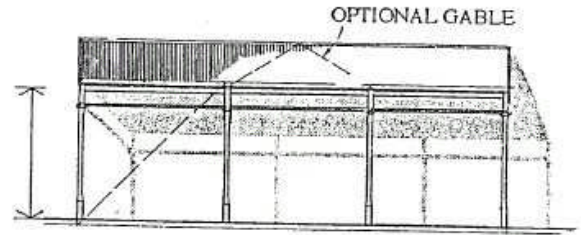

EIGHT TO WIDTH RATIO
APPROX 1:1

HEIGHT GOVERNED BY
HEIGHT OF STANDARD
DOOR & FANLIGHT

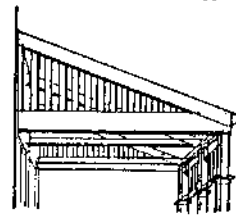

HEIGHT TO DEPTH RATIO
APPROX 1:1

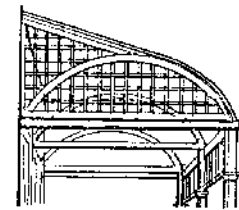

VERANDAH OPTIONS

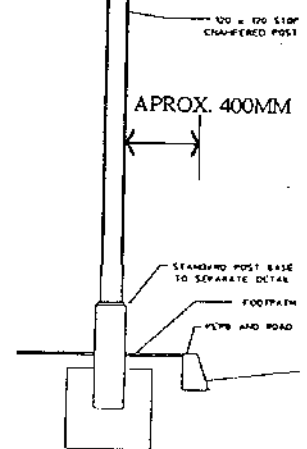
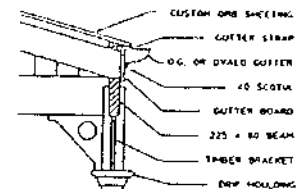
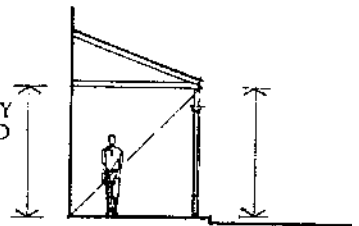
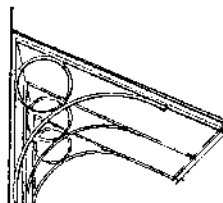
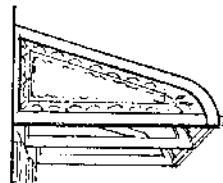
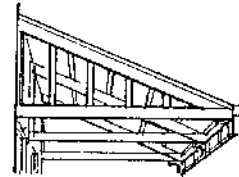

TYPICAL SECTION

Building Signage

Exterior identification signage only shall be permitted. It shall consist of painted signs with any illuminations being external to the sign. Signage shall be integral with the construction of the building.

Exterior signage shall be confined to traditional locations:

- Flush parapet signs.
- Projected hung signs from the upper facade – valance signs.
- Under verandah/awning signs.

Livery colour schemes shall not be permitted unless they conform with the preferred colour palette and are approved by the Town of Albany.

Window signage may be permitted. Permanent signage should be painted, stained or etched.

Advertising signage should be confined to internal display.

Sandwich boards and other forms of portable signage must comply with Council policy.

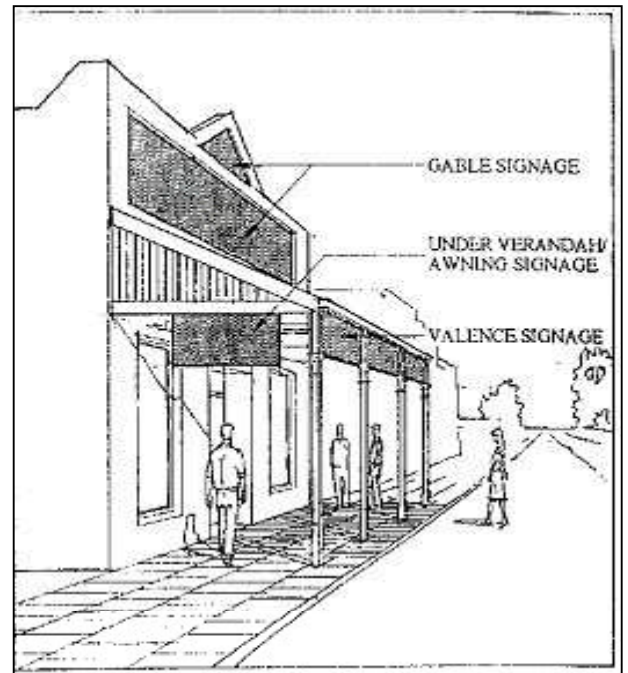

Courtyards

If courtyards are to be provided these should be on the north side of developments where hospitable climatic conditions can be assured.

Congeniality of scale and character must also be provided in courtyard spaces.

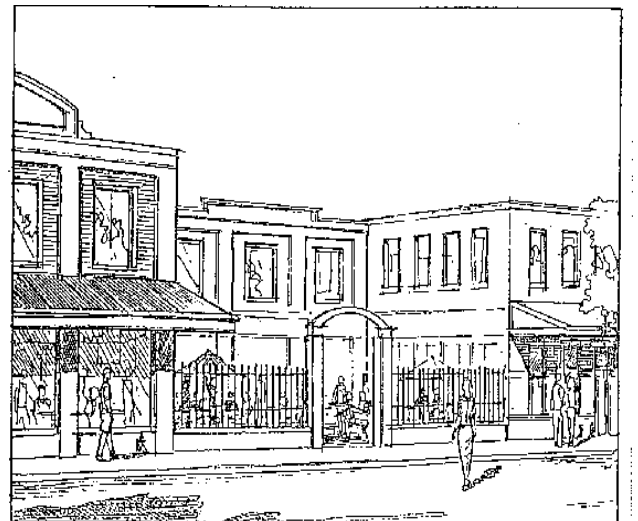

BUILDING DETAILS

Respectful Development

New buildings shall not ape or replicate heritage buildings. They shall, as far as possible, be contemporary buildings which utilise building vocabularies drawn from their immediate context, particularly heritage elements. These vocabularies shall include building types and configurations, orientation; heights; scale; roof forms; pitches and materials; wall materials, massing fenestration; opening details, eaves, awnings, veradahs, hoods, screens, chimneys; roof ornamentation, other ornamentation; building rhythms; colours, textures and qualities of materials and finishes, including signage.

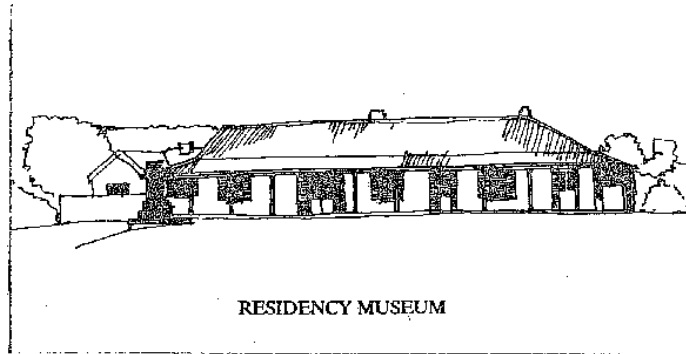

Design proposals shall be accompanied by detailed appraisal of the immediate context of all development proposals.

Vehicular Servicing

Off street servicing shall be walled from public view and shall, preferably, not occupy street frontage.

Vehicular crossing points shall be readily visible with adequate sightlines for pedestrian and vehicular safety.

Aerials, Collectors, etc

Structure and appurtenances such as radio and TV aerials, antennas, masts, dishes, solar collectors, air conditioners, plant and equipment etc which are normally roof mounted shall be concealed from view. The only exceptions which may be granted are to be proposals which can satisfactorily demonstrate that these appurtenances are an integral part of the design and contribute to the character and interest of the development.

Colour Schemes

Recommended colours for new buildings are provided in Appendix 2. Contemporary colour palettes or traditional palettes, compatible with the heritage buildings in the precinct will be considered, however approvals must be obtained from the Town of Albany or the Heritage Council, as applicable.

DEVELOPMENT STANDARDS

These shall be determined in accordance with the heritage requirements of the precinct.

Zonings/Land Uses

These are not applicable in this precinct as the heritage requirements and the museum uses are not bound by the Town of Albany, Town Planning Scheme. Ancillary uses and site planning factors impinging on surrounding roads and precincts shall need planning approvals.

Setbacks

There are not setback requirements from any boundary.

Landscaping

This shall be provided within hospitable courtyard spaces or to make the street presentation of service yards more attractive.

STREETSCAPE FACTORS

Streetscape

The integrity of the setting of heritage elements must be safeguarded ahead of other streetscape considerations.

Service Yards

Should be internalised to avoid visual impact on streetscape.

Street Furnishings

The type, nature and character of street furnishings and landscaping are illustrated in the accompanying landscape concept.

Streets, Car Parks, etc

All elements within the public domain shall be undertaken by the relevant development authorities. This will ensure consistent character and standard of implementation. The standard of these works shall indicate the development standards expected of private developers.

Pedestrian Access

All developments shall have direct pedestrian access through street frontages.

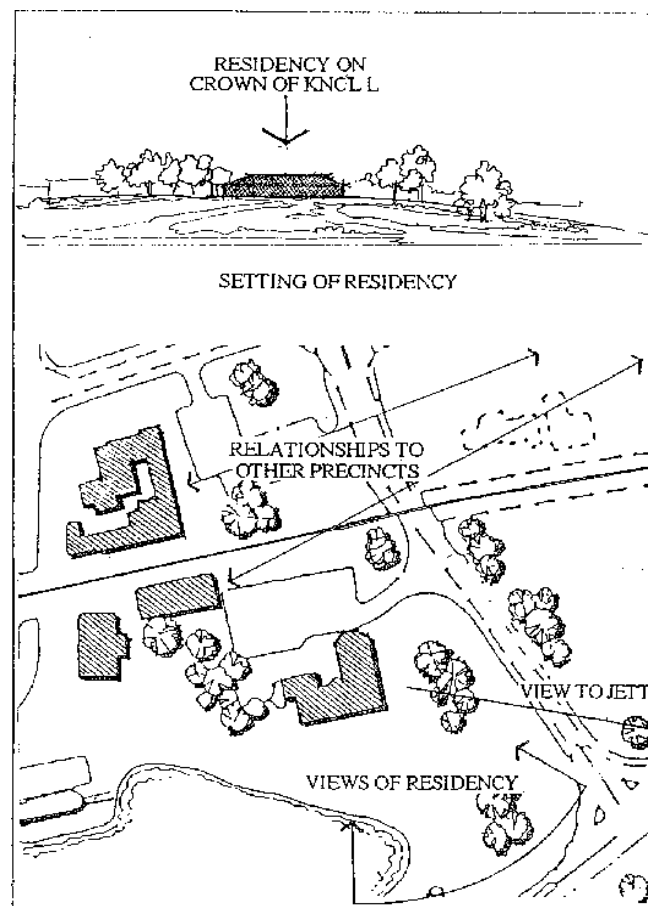

Vehicular Servicing

On street servicing shall be from designated kerb side loading bays only.

Off street servicing shall be walled from public view and shall, preferably, not occupy street frontage.

Vehicular crossing points shall be readily visible with adequate sightlines for pedestrian and vehicular safety.

Aerials, Collectors, etc

Structure and appurtenances such as radio and TV aerials, antennas, masts, dishes, solar collectors, air conditioners, plant and equipment etc which are normally roof mounted shall be concealed from view. The only exceptions which may be granted are to be proposals which can satisfactorily demonstrate that these appurtenances are an integral part of the design and contribute to the character and interest of the development.

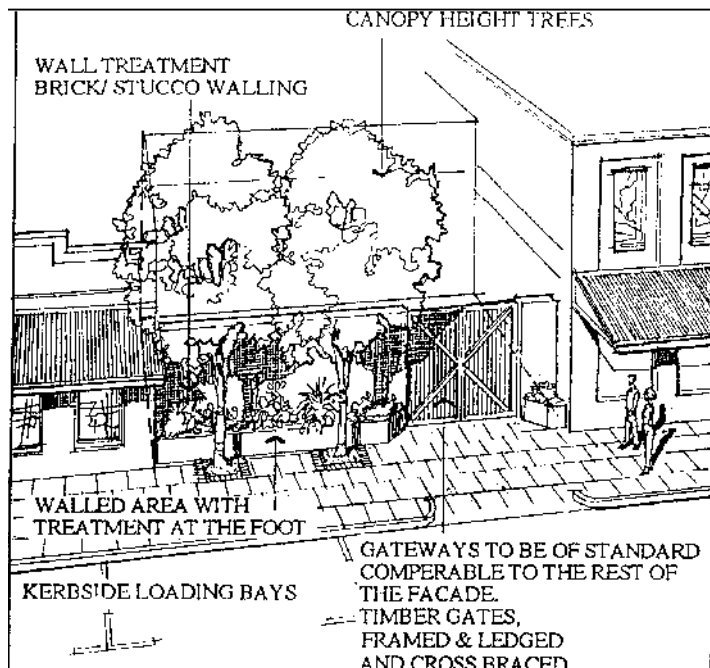

WESTERN PRECINCT GUIDELINES

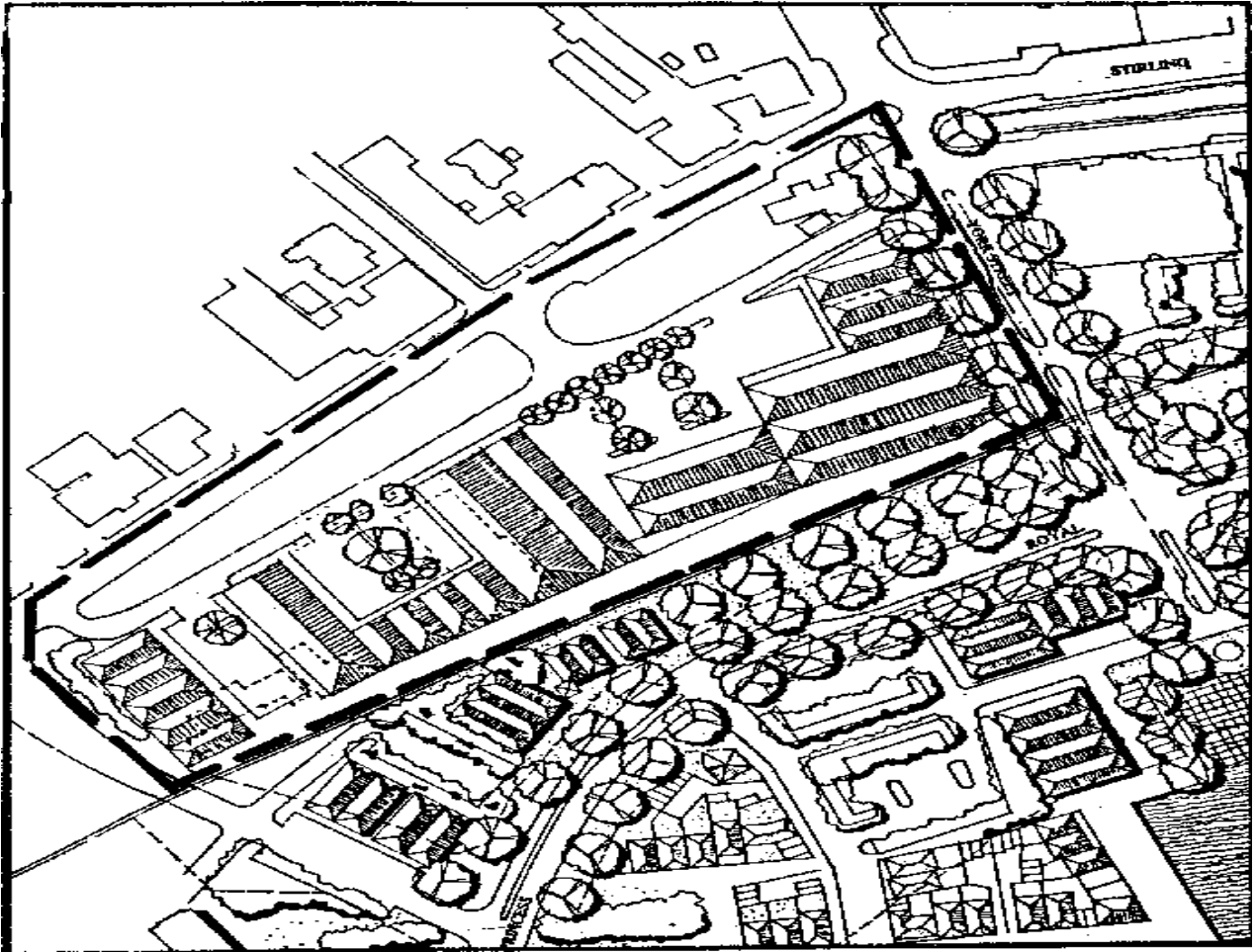

INTRODUCTION

Redevelopment within this precinct must achieve three urban design goals:

- It must physically complement the Station Precinct and reinforce its relationship with the Town proper;
- It must provide a transition between the Town proper and the Major Lockyer Park Precinct;
- It must encourage movement and activity between the Major Lockyer Park Precinct, the Town proper and the Station Precinct.

It is a precinct with strict controls as it occupies a prominent position as the Station Precinct. In this precinct the treatment of the facades is crucial to its character and must provide a transition to the historically important Major Lockyer Park Precinct. Its scale must mediate between the larger scale required of development at the foot of York Street and the more modest scale and considered patterning and detailed of the historic Major Lockyer Park Precinct.

Verandahs and Awnings

These shall comply with the dimensions shown opposite.

As far as possible there shall be continuity of shelter for pedestrian movement provided by verandahs and awnings.

Traditional structures and roofing materials shall be used.

Materials

The range of materials, traditionally used, and the relative extent of their use, are as follows:

- Brickwork, equivalent to dark blend Albany bricks or light blend Albany bricks.
- Painted render using Classical Revival proportioning and details.
- Painted timber boarding, joinery and verandah Glazing generally clear glass to windows, clear etched or patterned to door lights.
- Painted signs with external illumination only, when provided.
- Roofs in iron or shingle.

Colours

The traditional palette of colours used in this part of Albany is as follows:

Walls

Various ochre shades, cream, off-white, light pink, grey/blue.

Highlights

Black, dark brown, chocolate brown, dark green, rust.

Joinery

Dark Green, black, white, beige, turquoise, various browns.

Tiling

Dark green, mid-brown, white, coloured frieze tiles.
Verandah Dark green, mid to dark brown, white.

Roofs

Grey shingles or iron. Where visible this should be painted in dark green, dark red and/or cream.

Colour Schemes

Recommended colours are provided in Appendix 2. Contemporary colour palettes will be considered, however approvals must be obtained from the Town of Albany.

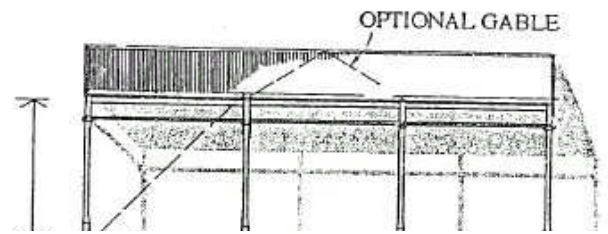

HEIGHT TO WIDTH RATIO
APROX 1:1

HEIGHT GOVERNED BY
HEIGHT OF STANDARD
DOOR & FANLIGHT

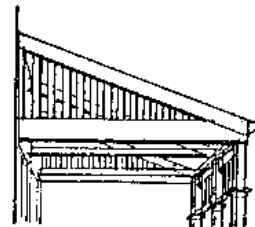

HEIGHT TO DEPTH RATIO
APROX 1:1

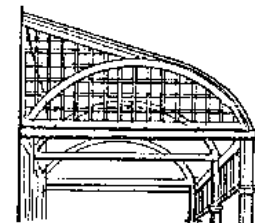
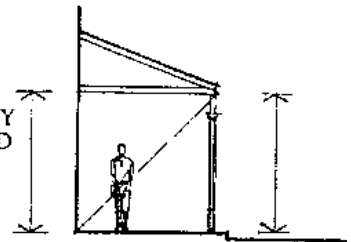

VERANDAH OPTIONS

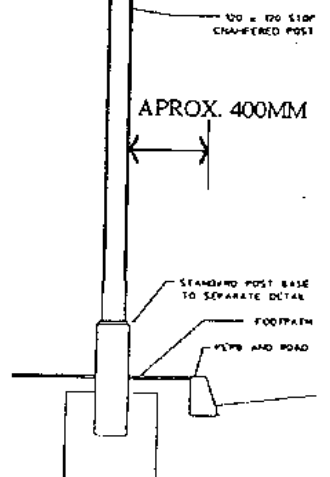
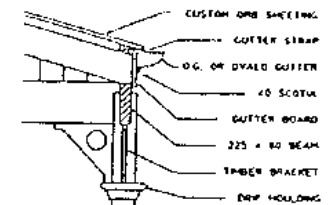
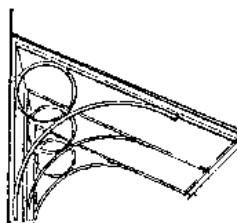
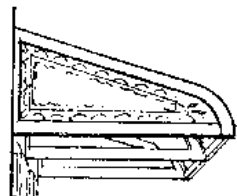
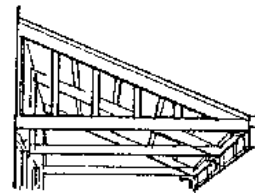

TYPICAL SECTION

Building Signage

Exterior identification signage only shall be permitted. It shall consist of painted signs with any illuminations being external to the sign. Signage shall be integral with the construction of the building.

Exterior signage shall be confined to traditional locations:

- Flush parapet signs.
- Projected hung signs from the upper facade – valance signs.
- Under verandah/awning signs.

Livery colour schemes shall not be permitted unless they conform with the preferred colour palette and are approval by the Town of Albany.

Window signage may be permitted. Permanent signage should be painted, stained or etched.

Advertising signage should be confined to internal display.

Sandwich boards and other forms of portable signage must comply with Council policy.

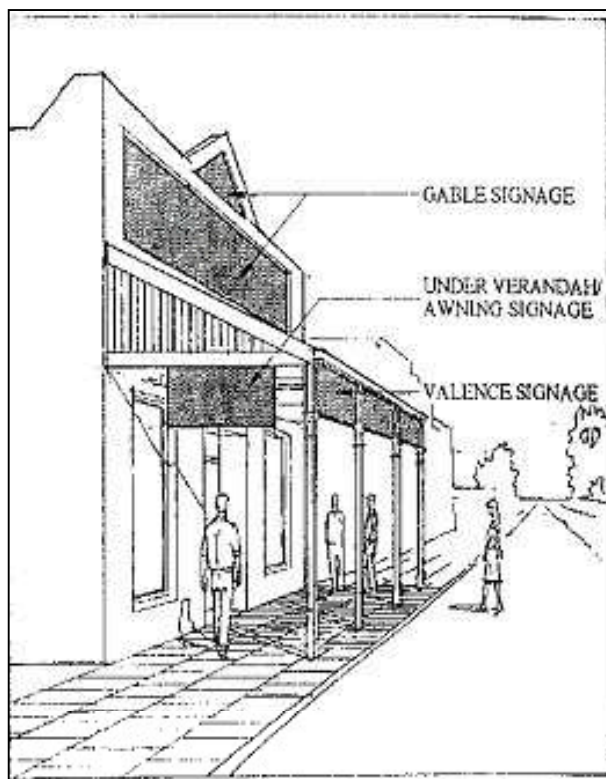

Vehicular Servicing

On street servicing shall be from designated kerb side loading bays only.

Off street servicing shall be walled from public view and shall, preferably, not occupy street frontage.

Vehicular crossing points shall be readily visible with adequate sightlines for pedestrian and vehicular safety.

Aerials, Collectors, etc

Structure and appurtenances such as radio and TV aerials, antennas, masts, dishes, solar collectors, air conditioners, plant and equipment etc which are normally roof mounted shall be concealed from view. The only exceptions which may be granted are to be proposals which can satisfactorily demonstrate that these appurtenances are an integral part of the design and contribute to the character and interest of the development.

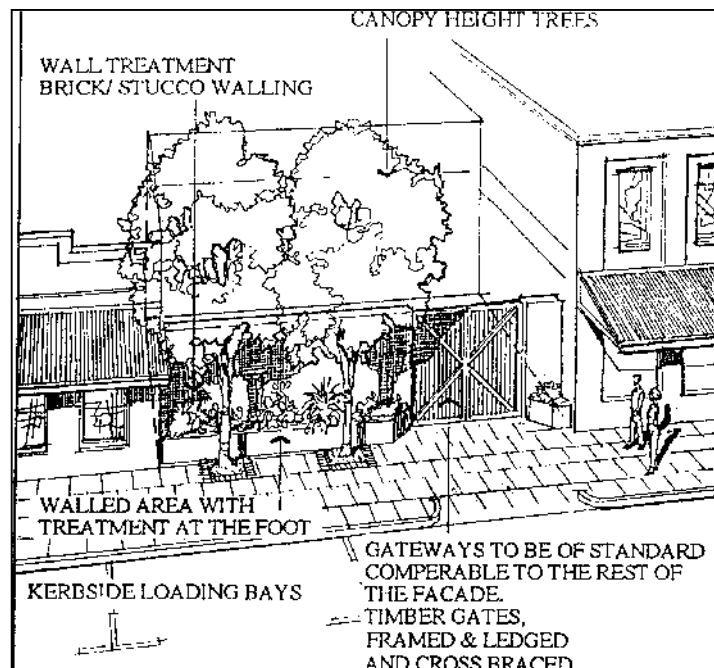

Development Sites

The size and location of development sites shall be determined in a master plan to meet the expanding needs of this precinct and to ensure the integrity of all heritage elements. Development sites will be determined in accordance with the master plan and all development proposals perused by the Albany Foreshores Development Committee, to ensure satisfaction of the development objectives, development guidelines and illustrated concept design.

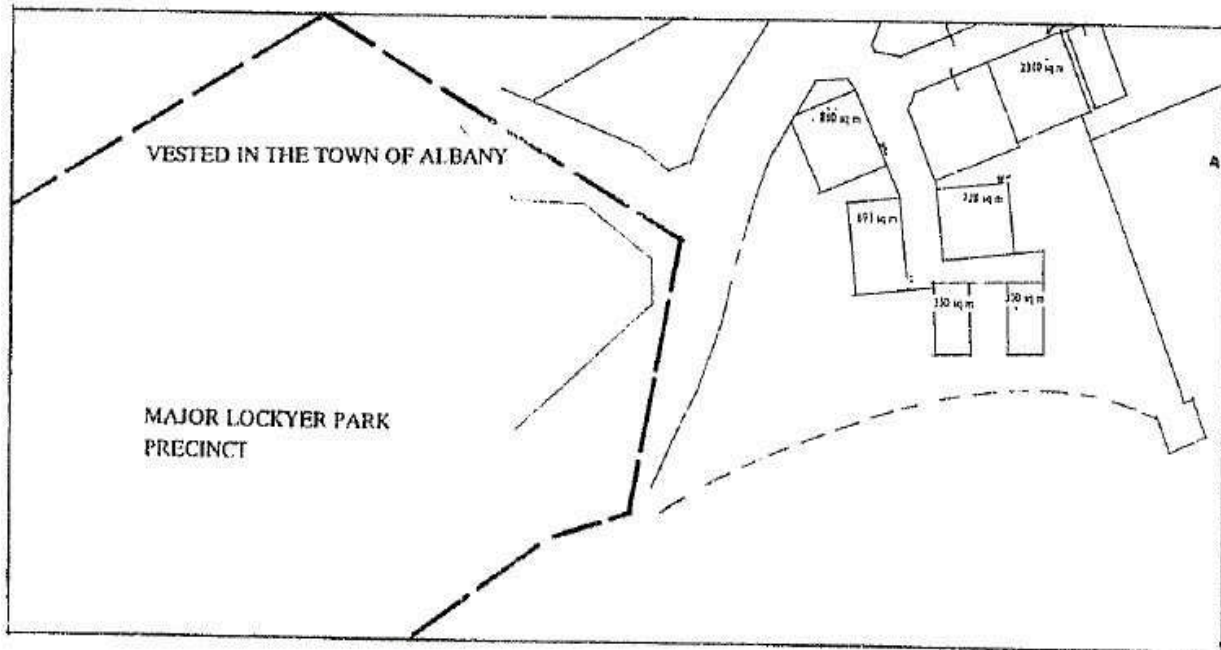

Land Tenure

The development sites defined shall be given the appropriate form of land tenure, which safeguards specific performance requirements based on the guidelines.

MAJOR LOCKYER PRECINCT GUIDELINES

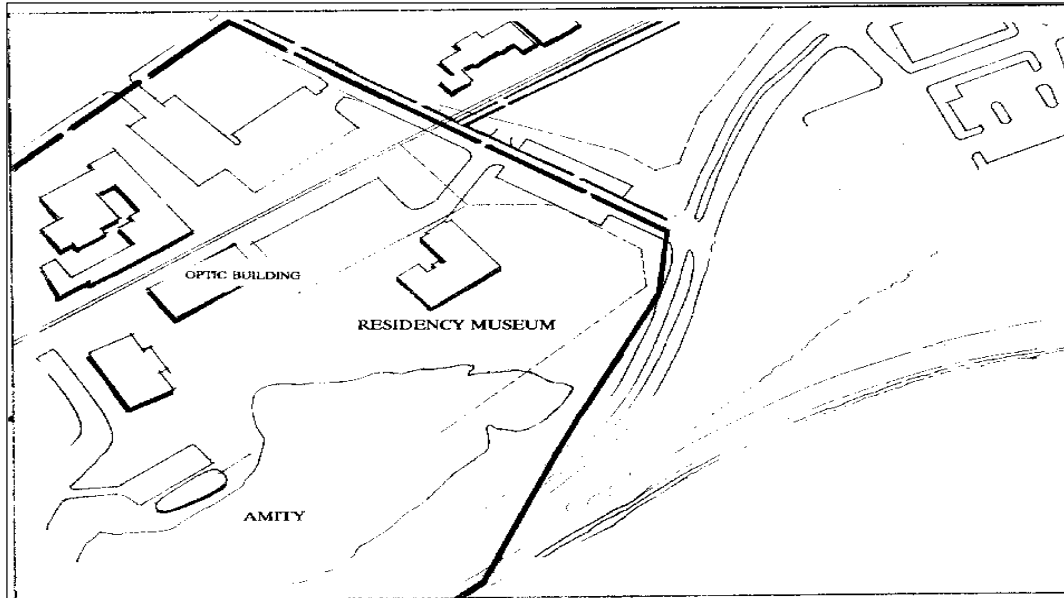

INTRODUCTION

Development within this historically important precinct must achieve the following urban design goals:

- The historical integrity and setting of this precinct and its heritage elements must be safeguarded.
- The visual relationships between this precinct and other parts of the town and foreshore must be retained.
- It is a major destination point for visitors to Albany and the foreshore and it must be attractively linked and highly accessible to the other foreshore precincts.

It is a precinct with strict controls because of the assessed heritage value of the precinct and its major elements. It is also a precinct which has established the identity of Albany in the minds of visitors. Development must reinforce the heritage value of the precinct and strengthen the precinct's role. Development should not emulate heritage places, but respect them in the manner of the Optic Building.

DEVELOPMENT SITES

Subdivision

The size and location of development sites is defined by the existing subdivisions. Development sites may be amalgamated and subdivided following planning approval of an appropriate development proposal, which satisfies the development objectives, development guidelines and illustrated concept design.

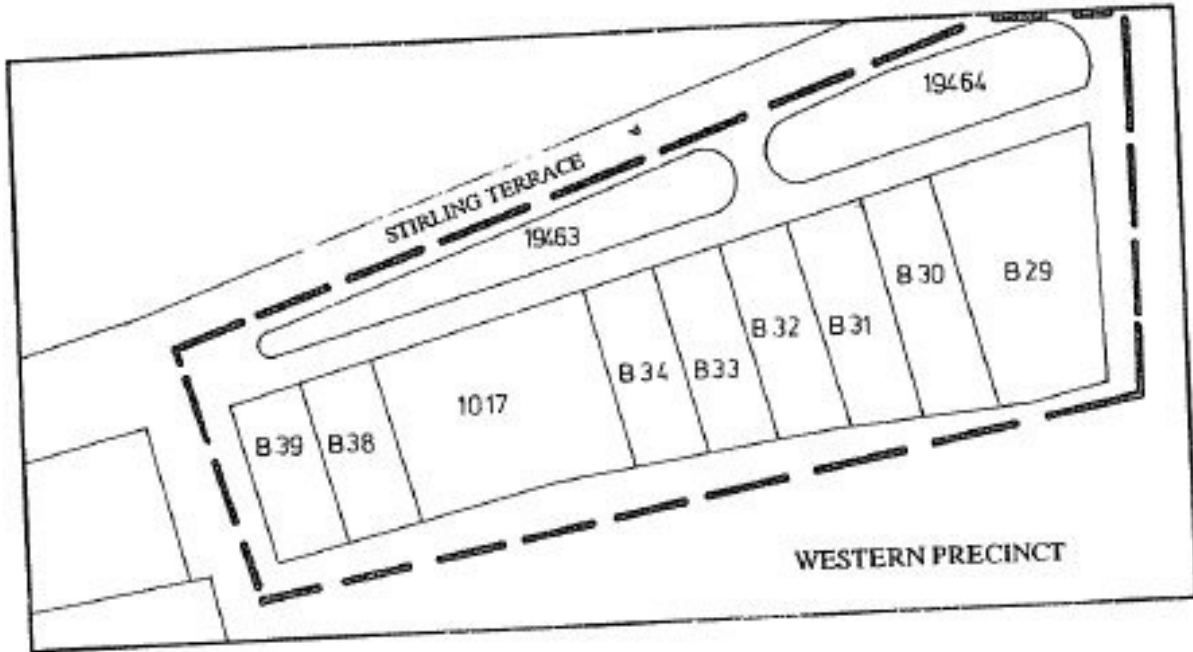

Site Definition

Development sites would benefit by communal car parking, which would need to be developed by the building owners in co-operation. Site boundaries may be redefined to meet the objectives of the guidelines, providing design proposals have been approved by the Albany Foreshores Development Committee.

DEVELOPMENT STANDARDS

All of the following standards shall be in accordance with the Town of Albany, Town Planning Scheme – Central Area Zone, unless otherwise noted.

Zonings/Land Uses

Various uses are permitted under the central area zone within the current Town of Albany Planning Scheme. The preferred uses are to be of a tourist orientation and by the nature of their operation be supportive of the tourism theme and/or the development of public facilities within the precinct.

Free standing fast food outlets, that are not integrated with adjacent shops, are unlikely to be approved, unless designed in a manner beneficial to the overall development of the precinct.

Plot Ratios

A maximum plot ration of 1.5 may be permitted, with a maximum of 2 storey height limit and 100% site cover, providing this is compatible with development in the vicinity.

Setbacks

There are not setback requirements from any boundary. Any setbacks will need to be justified in accordance with other provisions of these guidelines.

Landscaping

This shall provide an extension of the street landscaping themes or make the street presentation of service yards more attractive.

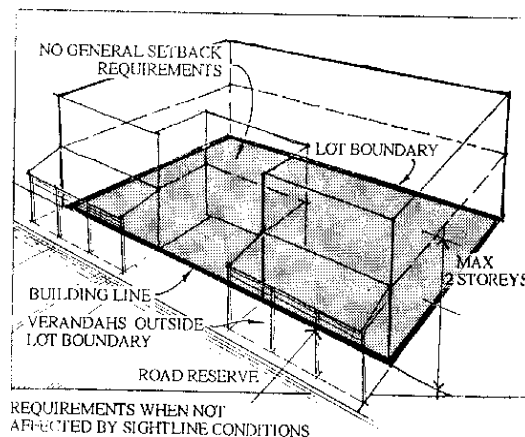

STREETSCAPE FACTORS

Streetscape

Appropriate streetscape characteristics of Upper Stirling Terrace should be emulated within this Precinct. For development this means:

- Facades constructed to maintain views from York Street to Major Lockyer Park Precinct.
- Pedestrian routes sheltered by awnings or verandahs.
- Facades should be 1 or 2 storeys in height.

Fronts

All developments must present “fronts” to Stirling Terrace, York Street and Residency Drive. Railway frontage must be attractively presented.

Setbacks

These are related to sightlines between important places.

Service Yards

Should be internalised to avoid visual impact on streetscapes.

Street Furnishings

The type, nature and character of street furnishings and landscaping are illustrated in the accompanying landscape concept.

Streets, Car Parks, etc

All elements within the public domain shall be undertaken by the relevant development authority.

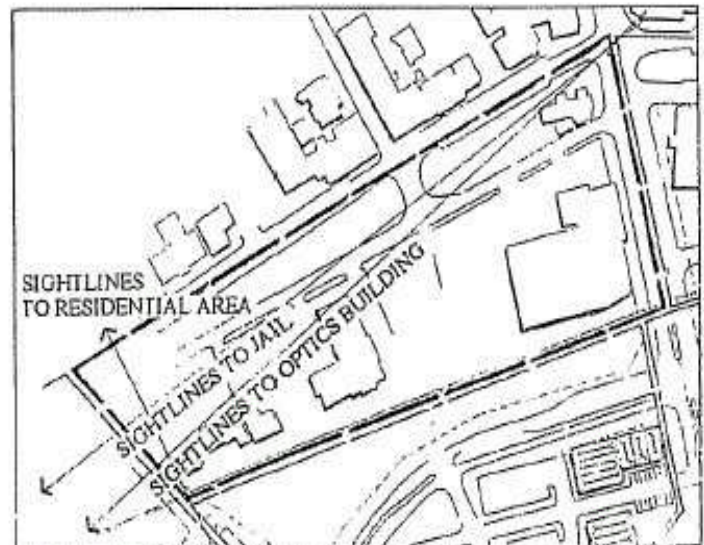
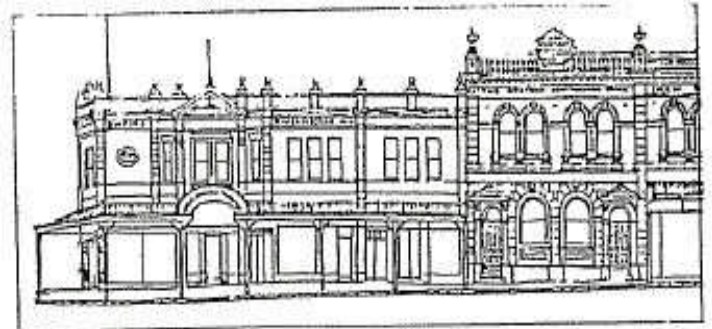

BUILDING DETAILS

Building Heights

All buildings shall be 1 or 2 storeys in height 4.5-8m facade heights.

Features, such as towers, may be permitted to exceed 2 storeys in height.

Walls

Generally walls shall be of masonry or timber construction with holes for windows and doors.

Walls should be articulated into a base, middle and capping.

Walls should be articulated into bays not exceeding 6m in length.

Exceptions to this shall be retail frontages under verandahs or awnings, where the proportion of void to solid may increase.

Roofs

All roofs shall be pitched. Roof pitches are to within the range 26.5-45. From eave to ridge roof heights shall not exceed 4m. Roofs shall be gabled or hipped ends, unless parapeted. Generally eaves shall be finished flush with walls, unless forming a verandah.

Openings

Apart from retail frontages door and window openings shall be inset from the façade by, at least 125mm. Openings should be articulated to set up façade rhythms.

Door openings shall be indented from the facade by, at least, 750mm.

Retail frontages shall consist of:

- Tiled recessed entry.
- Thin timber or bronze shopfrontings.
- Timber or tiles stall boards.
- Plate glass glazing.
- Timber part-glazed doors.

